



ROYAL GARDEN
EST. 1992









MANIFESTO

EN At Royal Garden, we create enduring outdoor products that fuse sophistication, resilience, and ultimate tranquility.

Our creations transform open-air spaces into inviting retreats, designed for lasting enjoyment. Crafted with expertise, we offer seamless solutions for a supreme outdoor experience.

DE Bei Royal Garden kreieren wir langlebige Produkte für den Außenbereich, die Raffinesse, Widerstandsfähigkeit und ultimative Ruhe miteinander verbinden.

Unsere Kreationen verwandeln Freiflächen in einladende Rückzugsorte, die für einen dauerhaften Genuss konzipiert sind, und bieten nahtlose Lösungen für ein erstklassiges Outdoor-Erlebnis.

FR Chez Royal Garden, nous créons des produits d'extérieur durables qui allient sophistication, résistance et sérénité absolue.

Nos créations transforment les espaces en plein air en refuges accueillants, conçues pour un plaisir qui s'inscrit dans le temps. Fabriquées avec expertise, nous offrons des solutions sans faille pour une expérience extérieure incomparable.

DINING & LOUNGING

NORDEN

□ 12



NORLAND

□ 24



VILA NOVA

□ 34



PULSE

□ 44



KEMO

□ 52



FOCOSA

□ 62



SKOVBRYN

□ 74



ELEGANCE

□ 80



EXCELSIOR

□ 88



CAFFEO

□ 94



ROYAL RICHMOND

□ 100



ROYAL KENSINGTON PLUS

□ 106



ROYAL KENSINGTON

□ 108



OPERA

□ 114



ROYAL DAYBED DELUXE

□ 120



TABLES

NOMAD
□ 128



FREE
□ 130



DESERT
□ 132



PI
□ 138



URBAN
□ 142



SHADES

ROYAL NIDO
□ 152



ROYAL CORO
□ 156



ROYAL SQUARO
□ 160



ROYAL QUATTRO
□ 164





Materials

ALUMINIUM

EN

Light, yet sturdy and weather-resistant: Aluminium furniture guarantees an easy and comfortable time outdoors in all aspects. It offers modern comfort, and is extremely easy to care for. Additionally, it has a high-quality coating for additional protection against external influences. Aluminium - simply the ideal choice for taking life easy.

DE

Leicht und dennoch stabil und witterungsbeständig: Gartenmöbel aus Aluminium garantieren eine in jeder Hinsicht unkompliziert bequeme Zeit unter freiem Himmel. Sie bieten modernen Komfort, sind ausgesprochen pflegeleicht und erhalten durch eine hochwertige Beschichtung zusätzlichen Schutz vor äußeren Einflüssen. Aluminium - einfach die ideale Wahl, um das Leben locker zu nehmen.

FR

Léger, mais solide et résistant aux intempéries : le mobilier de jardin en aluminium garantit, à tous égards, des moments de confort et de simplicité en plein air. Il offre un confort contemporain, demande très peu d'entretien, et bénéficie d'une protection renforcée contre les agressions extérieures grâce à un revêtement de qualité. L'aluminium : tout simplement le choix idéal pour prendre la vie à la légère.



TEAK

EN

Natural elegance meets design: FSC®-certified teak wood

Selected products in our range are refined with FSC®-certified teak wood – a material that impresses with its natural texture and warm appearance. In combination with aluminum frames, it creates a sophisticated contrast that unites modern design with organic aesthetics. Teak is not only visually appealing but also highly functional: low-maintenance, weather-resistant, and comfortable – ideal for outdoor use. Please look out for our FSC®-certified products – clearly marked throughout this catalog.

DE

Natürlichkeit trifft Design – FSC®-zertifiziertes Teakholz

Ausgewählte Produkte unseres Sortiments werden durch FSC®-zertifiziertes Teakholz veredelt – ein Material, das mit seiner natürlichen Haptik und warmen Optik begeistert. In Kombination mit Gestellen aus Aluminium entsteht ein stilvoller Kontrast, der modernes Design mit organischer Ästhetik verbindet. Dabei überzeugt Teak nicht nur visuell, sondern auch funktional: pflegeleicht, wetterfest und komfortabel – ideal für den Einsatz im Außenbereich. Bitte achten Sie auf unsere FSC®-zertifizierten Produkte – sie sind in diesem Katalog entsprechend gekennzeichnet.

FR

L'élégance naturelle au service du design : bois de teck certifié FSC®

Certains produits de notre gamme sont sublimés par du bois de teck certifié FSC® – un matériau qui séduit par son toucher naturel et son apparence chaleureuse. Associé à des structures en aluminium, il crée un contraste élégant qui marie design moderne et esthétique organique. Le teck convainc non seulement par son aspect, mais aussi par ses qualités pratiques : facile d'entretien, résistant aux intempéries et confortable – parfait pour une utilisation en extérieur. Repérez facilement nos produits certifiés FSC® grâce aux symboles dédiés dans ce catalogue.



FAIRSTONE

EN

Inspired by natural stone, concrete, and metal, Fairstone® combines aesthetics and functionality at the highest level. The authentic representation of textures and colors creates a natural, noble appearance – clear, minimalist, and timelessly beautiful. Various surface finishes result in a distinctive tactile experience that enhances every design.

- Realistic stone and concrete appearance
- Premium tactile feel through various finishes
- Resistant, easy to maintain, and durable
- Ideal for outdoor applications

DE

Inspiriert von natürlichem Stein, Beton und Metall, vereint die Fairstone® Ästhetik und Funktionalität auf höchstem Niveau. Die authentische Darstellung von Texturen und Farben schafft eine natürliche, edle Optik – klar, reduziert und zeitlos schön. Durch verschiedene Oberflächenveredelungen entsteht eine charaktervolle Haptik, die jede Gestaltung aufwertet.

- Realistische Stein- und Betonoptik
- Hochwertige Haptik durch unterschiedliche Veredelungen
- Widerstandsfähig, pflegeleicht und langlebig Ideal für Außenanwendungen

FR

Inspirée par la pierre naturelle, le béton et le métal, Fairstone® combine esthétique et fonctionnalité au plus haut niveau. La reproduction authentique des textures et des couleurs offre un rendu naturel et raffiné – clair, minimaliste et d'une beauté intemporelle. Les différentes finitions de surface apportent une expérience tactile unique qui valorise chaque conception.

- Aspect réaliste de la pierre et du béton
- Toucher qualitatif grâce à des finitions variées
- Résistante, facile à entretenir et durable
- Parfaite pour les aménagements extérieurs





TEXTILES

EN

Mass dyed fabrics are a global benchmark in performance textiles, originally developed for marine use and now widely used in home furnishings.

Combining durability, design, and creativity, these high-quality collections are suited for both indoor and outdoor spaces. Made from solution-dyed acrylic fibers, they offer UV resistance, are stain-protected, washable, and even bleach-cleanable for tougher stains.

DE

Massengefärbte Stoffe sind weltweit ein Maßstab für leistungsstarke Textilien – ursprünglich für den maritimen Bereich entwickelt, heute weit verbreitet im Wohnbereich.

Durch die Kombination aus Langlebigkeit, Design und Kreativität eignen sich diese hochwertigen Kollektionen für den Innen- und Außenbereich. Sie bestehen aus lösungsgefärbten Acrylfasern, sind UV-beständig, fleckenabweisend, waschbar und bei hartnäckigen Flecken sogar mit verdünntem Bleichmittel zu reinigen.

FR

Les tissus teints dans la masse sont une référence mondiale en matière de textiles techniques, d'abord conçus pour le nautisme et désormais largement utilisés dans l'ameublement.

Alliant durabilité, design et créativité, ces collections de haute qualité conviennent aussi bien à l'intérieur qu'à l'extérieur. Fabriqués à partir de fibres acryliques teintes dans la masse, ils offrent une résistance aux UV, sont traités contre les taches, lavables et même nettoyables à l'eau de javel diluée pour les taches tenaces.

POLYTEX®

EN

Polytex® is a synthetic textile fiber made from a blend of PVC-coated polyester and olefin. It contains 30% less PVC. It is water-repellent, UV- and abrasion-resistant, and easy to maintain.

DE

Polytex® ist eine synthetische Textilfaser, hergestellt aus einer Mischung aus PVC-beschichtetem Polyester und Olefin. Sie enthält 30 % weniger PVC. Sie ist wasserabweisend, UV- und abriebfest sowie pflegeleicht.

FR

Le polytex® est une fibre textile synthétique fabriquée à partir d'un mélange de polyester enduit de PVC et d'oléfine. Il contient 30% de PVC en moins. Il est déperlant, résistant aux UV et à l'abrasion, et facile d'entretien.





WICKER & ROPE

EN

Crafted with expertise, synthetic wicker furniture offers the natural look and feel of traditional materials while outperforming them in durability and weather resistance. Made from high-quality, outdoor-grade polyethylene fibers, it is weatherproof, long-lasting, and low-maintenance.

The same advantages apply to our rope, which is made with high-quality synthetic polymers fibers.

- Natural look and haptics
- Weatherproof
- Resilient and durable
- Easy to care for



DE

Mit fachmännischer Handwerkskunst gefertigt, bietet Möbel aus synthetischem Geflecht das natürliche Aussehen und Gefühl traditioneller Materialien, übertrifft diese jedoch in Haltbarkeit und Wetterbeständigkeit. Hergestellt aus hochwertigen Polyethylenfasern in Outdoor-Qualität ist das Material wetterfest, langlebig und pflegeleicht.

Die gleichen Vorteile gelten auch für unser Seil, das aus hochwertigen synthetischen Polymerfasern besteht.

- Natürliche Optik und Haptik
- Witterungsbeständig
- Widerstandsfähig und langlebig
- Pflegeleicht

FR

Fabriqué avec un savoir-faire expert, le mobilier en résine tressée synthétique offre l'apparence et le toucher des matériaux naturels tout en les surpassant en termes de durabilité et de résistance aux intempéries. Composé de fibres de polyéthylène de haute qualité conçues pour l'extérieur, il est résistant aux intempéries, durable et facile d'entretien.

Les mêmes avantages s'appliquent à notre corde, fabriquée à partir de fibres polymères synthétiques de haute qualité.

- Aspect et toucher naturels
- Résistant aux intempéries
- Robuste et durable
- Facile d'entretien



NORDEN

Nordic Comfort, Outdoors

EN Norden is a sleek outdoor furniture range crafted from open synthetic rattan, inspired by minimalist Nordic design. Its soft, curved lines and airy weave create a light, modern look, while plush cushions offer supreme comfort. Durable and weather-resistant translates into effortless Scandinavian elegance to your outdoor space.

Nordischer Komfort für draußen

DE Norden ist eine elegante Außenmöbelserie aus offenem synthetischem Rattan, inspiriert vom minimalistischen nordischen Design. Die weichen, geschwungenen Linien und das luftige Geflecht sorgen für einen leichten, modernen Look, während die weichen Kissen höchsten Komfort bieten. Langlebig und witterungsbeständig, verleihen sie Ihrem Außenbereich mühelos skandinavische Eleganz.

Le confort nordique en plein air

FR Norden est une gamme de meubles d'extérieur élégants fabriqués à partir de rotin synthétique ajouré, inspiré par le design nordique minimaliste. Ses lignes douces et incurvées, associées à un tissage aéré, offrent un look léger et contemporain, tandis que les coussins moelleux garantissent un confort optimal. Durable et résistante aux intempéries, cette collection incarne l'élégance scandinave sans effort, pour sublimer votre espace extérieur.







EN **Norden** corner set with: corner element; two seater sofa left; two seater sofa right; side Table rect.; Armchair

DE **Norden** Eckgarnitur mit: Eckelement; zweisitzer-Sofa links; zweisitzer-Sofa rechts; Lounge Tisch; Sessel

FR **Norden** Salon d'angle composé d'un canapé 2 places gauche, un canapé 2 places droite, un fauteuil et une table basse rectangulaire



EN **Norden** lounge sofa set with: two seater sofa; two sofa chairs; side table rect.; two round side tables

DE **Norden** lounge Sofa mit: zweisitzer-Sofa; Lounge Tisch rechteckig; zwei Sessel; zwei runde Lounge Tische

FR **Norden** Salon composé d'un canapé 2 places, deux fauteuils, une table basse rectangulaire et 2 tables basses rondes

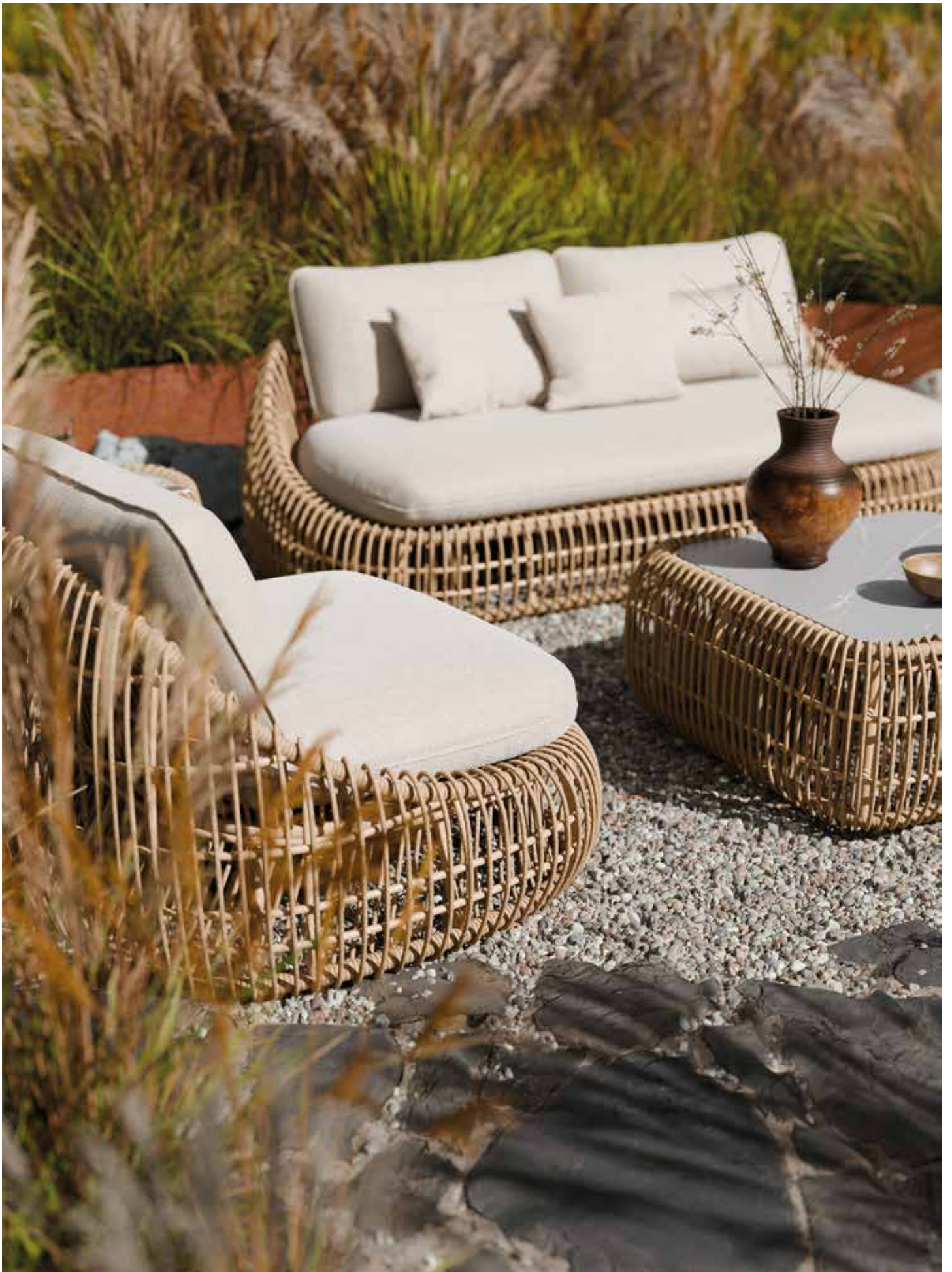



EN **Norden** dining set with: **Desert** oval dining table; **Norden** light dining chairs

DE **Norden** dining set mit: **Desert** ovaler Esstisch; **Norden** light dining Stühle

FR **Norden** Salon repas avec une table de repas ovale **Desert** et fauteuils de repas **Norden** modèle light





EN **Norden** dining set with: **Free** dining table; **Norden** dining chairs
DE **Norden** dining set mit: **Free** Esstisch; **Norden** dining Stühle
FR **Norden** Salon repas avec une table de repas **Free** et fauteuils de repas **Norden**



EN Bistro set with: **Norden** dining chairs; **Desert** bistro table
DE Bistro set mit: **Norden** Sessel; **Desert** bistro tisch
FR Ensemble de bistro avec fauteuils **Norden** et table **Desert**

NORDEN



Aluminium Frame / Aluminiumrahmen /
Structure Aluminium



Wicker / Kunststoffgeflecht / résine tressée



Removable cushions in spun polyester 190 g. / Abnehmbare
Kissen aus 440 gr. Spunpolyester / Coussins déhoussables
spunpolyester 190 gr.



Colour / Farbe / Couleur: Sand



6 mm Fairstone Tabletop / Plateau / Tischplatte



water-repellant / wasserabweisend / déperlant



Protective cover included / inklusive Schutzhülle /
Housse de protection inclus



154106
Sofa Set / Sofaset /
Salon de jardin

 02/Set



154100
Corner Sofa /
Ecksofa / Canapé d'angle

 02/Set



154101
Armchair /
Sessel / Fauteuil

 02



Two Seater Sofa /
Zwei Sitzer Sofa /
Canapé 2 places



Corner element /
Eck-Element / Extension canapé
d'angle



Two Seater Sofa /
Zwei-Sitzer Sofa /
Canapé 2 places



Two Seater Sofa /
Zwei Sitzer Sofa /
Canapé 2 places

Norden min. space / kleinste Fläche / espace minimum

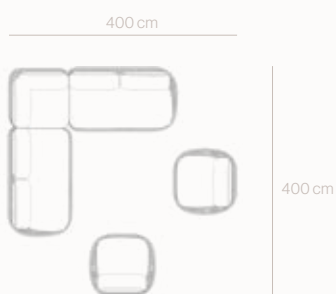



84 cm

67,5 cm 60,5 cm

154124
Chair / Stuhl / Fauteuil

02



80 cm

61 cm 61 cm

154125
Chair / Stuhl / Fauteuil

02



37,5 cm

90 cm 90 cm

154121
Side Table /
Lounge Tisch /
Table basse

01



37,5 cm

80,5 cm 125,5 cm

154118
Side Table /
Lounge Tisch /
Table basse

01

○ 57 cm



41 cm

154122
Side Table /
Lounge Tisch /
Table basse

02

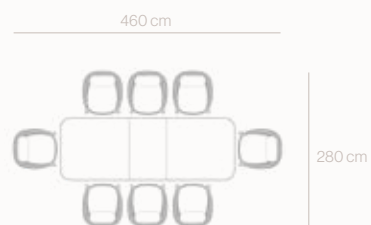



NORLAND

Bold Style, Smart Living

EN NORLAND is designed for compact spaces. Vibrant, eye-catching colours, featuring lightweight aluminum frames and finished with wood-effect armrest accents, is the perfect formula that brings playful charm to patios, balconies and hospitality spaces. Combine it with our bistro tables for a perfect match, and stack the chairs when not in use for easy storage. NORLAND is durable, long-lasting, and entirely maintenance free—ideal for modern outdoor living.

Mutiger Stil, intelligentes Wohnen

DE NORLAND ist für kompakte Räume konzipiert. Kräftige, auffällige Farben, leichte Aluminiumrahmen und Armlehnen in Holzoptik - das ist die perfekte Formel, die Terrassen, Balkone und Gasträume mit spielerischem Charme bereichert. Kombinieren Sie ihn mit unseren Bistrotischen und stapeln Sie die Stühle, wenn sie nicht gebraucht werden, um sie einfach zu verstauen. NORLAND ist robust, langlebig und völlig wartungsfrei - ideal für das moderne Leben im Freien.

Style audacieux, vie intelligente

FR NORLAND a été pensé pour les espaces compacts. Ses couleurs vives et dynamiques, ses structures en aluminium léger et ses accoudoirs au fini bois en font la solution idéale pour apporter une touche ludique aux terrasses, balcons et espaces d'accueil. Associez-le à nos tables bistrot pour créer un ensemble harmonieux, puis empilez facilement les chaises lorsqu'elles ne sont pas utilisées. NORLAND est durable, résistant aux intempéries et sans entretien — le choix parfait pour une vie moderne en plein air.







EN **Norland** armchair; **Desert** bistro table
DE **Norland** Sessel; **Desert** bistro tisch
FR **Norland** fauteuils; table **Desert**



EN Bistro set with: **Norland** stacking armchairs; **Desert** bistro table
DE Bistro set mit: **Norland** Stapelstühlen; **Desert** bistro tisch
FR Ensemble de bistro avec fauteuils empilables **Norland** et table **Desert**





EN **Norland** stacking armchairs; **Urban** folding table
DE **Norland** Stapelstuhl; **Urban** Klapp Tisch
FR **Norland** fauteuils empilables; **Urban** table pliante





NORLAND



Aluminium Frame / Aluminiumrahmen / structure aluminium



Armrest / Armlehne / Accoudoir:
Wood look / Holzoptik / Aspect bois



water-repellant / wasserabweisend / déperlant



Protective cover included / inklusive Schutzhülle /
Housse de protection inclus



154228
Stacking armchair /
Stapelstuhl / Fauteuil empilable
Colour / Farbe / Couleur:
■ Sand

22



154230
Stacking armchair /
Stapelstuhl / Fauteuil empilable
Colour / Farbe / Couleur:
■ Anthracite

22



154245
Stacking lounge armchair /
Stapelbarer Lounge-Sessel /
Fauteuil de salon empilable
Colour / Farbe / Couleur:
■ Sand

22



154790
Cushion for Stacking Armchairs /
Kissen für Stapelstühle / Coussin
pour fauteuils empilables

Olefin: water-repellant /
wasserabweisend / déperlant

Colour / Farbe / Couleur:
■ Sand

12



154019
Cushion for Stacking Armchairs /
Kissen für Stapelstühle / Coussin
pour fauteuils empilables

Olefin: water-repellant /
wasserabweisend / déperlant

Colour / Farbe / Couleur:
■ Anthracite

12

NORLAND min. space / kleinste Fläche / espace minimum





VILA NOVA

Made for pure relaxation

EN Hand-woven in all-weather rope around lightweight aluminum frames, each piece balances comfort and ease. Available in off white and olive green, the collection features deep-comfortable cushions that invite you to slowdown and stay a while. Whether on a sun-drenched terrace or a shaded patio, VILLA NOVA brings serene comfort to outdoor living.

Gemacht für pure Entspannung

DE Die handgeflochtenen, wetterfesten Seile um die leichten Aluminiumrahmen bieten ein ausgewogenes Verhältnis zwischen Komfort und Bequemlichkeit. Die Kollektion ist in den Farben Off White und Olive Green erhältlich und verfügt über tiefe, bequeme Kissen, die zum Verweilen einladen. Ob auf einer sonnenverwöhnten Terrasse oder einem schattigen Patio, VILLA NOVA bringt heiteren Komfort ins Outdoor-Leben.

Pour une pure détente

FR Tissé à la main avec une corde résistante aux intempéries sur une structure en aluminium léger, chaque pièce incarne un équilibre parfait entre confort et simplicité. Disponible en blanc cassé et en vert olive, la collection se distingue par ses assises profondes et confortables, qui invitent à la détente et à la contemplation. Que ce soit sur une terrasse ensoleillée ou un patio ombragé, VILA NOVA insuffle un confort serein à chaque instant de vie en plein air.







EN **Vila Nova** corner sofa with **Pi** tables
DE **Vila Nova** Ecksofa mit **Pi** Tischen
FR **Vila Nova** canapé d'angle avec tables **Pi**



EN **Vila Nova** lounge sofa set with: three seater sofa; two armchairs; **Desert** side table; Two round **Pi** lounge tables
 DE **Vila Nova** lounge Sofa Set mit: Dreisitzer-Sofa; **Desert** Beistelltisch; zwei Sessel; zwei runde **Pi** lounge Tische
 FR **Vila Nova** Salon composé d'un canapé 3 places, deux fauteuils; avec **Desert** tables basses et de deux tables basses rondes **Pi**





EN Bistro set with: **Vila Nova** dining armchairs; **Desert** bistro table
DE Bistro set mit: **Vila Nova** dining Stühlen; **Desert** Bistro Tisch
FR Ensemble de bistro avec: fauteuils **Vila Nova**; **Desert** table de bistro



EN Dining set with: **Vila Nova** dining armchairs; **Desert** dining table
DE Dining Set mit: **Vila Nova** dining Stühlen; **Desert** Esstisch
FR Ensemble de repas avec: fauteuils **Vila Nova**; **Desert** table

VILA NOVA



Aluminium Frame / Aluminiumrahmen / structure aluminium



Rope covering / Seilbespannung / cordage



Removable cushions in 280 g Acrylic. / Abnehmbare Kissen aus 280 gr. Acryl / Coussins déhoussables acryl 280 gr.



Colour / Farbe / Couleur: Sand



water-repellant / wasserabweisend / déperlant



Protective cover included / inklusive Schutzhülle / Housse de protection inclus



154221
Corner Sofa /
Ecksofa / Canapé d'angle



154223
Sofa Set



154227
Armchair / Stuhl / Fauteuil



Vila Nova min. space / kleinste Fläche / espace minimum

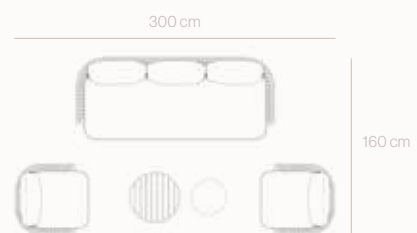
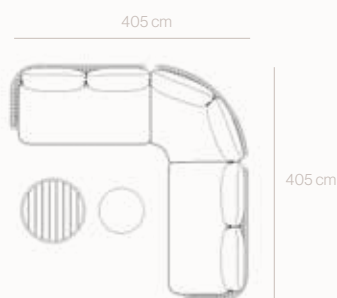



154222
 Armchair /
 Sessel / Fauteuil

02



154224
 Two Seater Sofa /
 Zwei Sitzer Sofa /
 Canapé 2 places

01

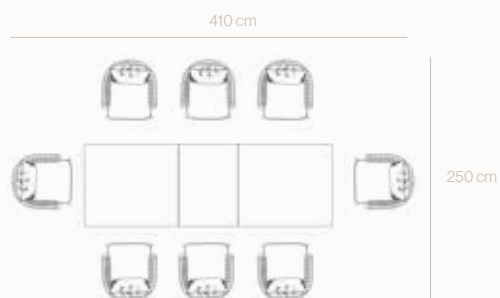
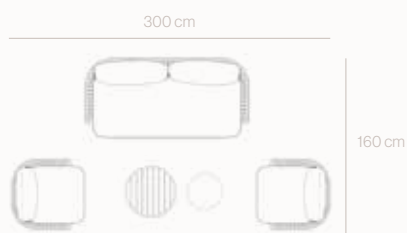



PULSE

Woven Strength, Refined Comfort

EN This elegant range of outdoor dining chairs blends artisanal craftsmanship with durable design. Hand-woven in all-weather rope and set on sturdy steel bases, each chair offers lasting support and sophisticated texture. Available in three timeless colors—off-white, black, and taupe—they fit seamlessly into any outdoor dining setting. A soft cushion adds an extra layer of comfort, making every meal feel effortlessly relaxed.

Geflochtene Stärke, raffinierter Komfort

DE Diese elegante Serie von Outdoor-Esstühlen vereint handwerkliche Kunstfertigkeit mit langlebigem Design. Von Handgeflochten mit wetterfestem Seil und auf stabilen Stahlgestellen platziert, bietet jeder Stuhl dauerhafte Unterstützung und eine stilvolle Textur. Erhältlich in drei zeitlosen Farben – Off-White, Schwarz und Taupe – fügen sie sich nahtlos in jede Outdoor-Essumgebung ein. Ein weiches Sitzkissen sorgt für zusätzlichen Komfort und macht jede Mahlzeit angenehmer.

Solidité tressée, confort raffiné

FR Cette élégante gamme de chaises de repas d'extérieur allie savoir-faire artisanal et design durable. Tressées à la main avec une corde résistante aux intempéries et montées sur des structures en acier robuste, chaque chaise offre un soutien fiable et une texture sophistiquée. Disponibles en trois teintes intemporelles – blanc cassé, noir et taupe – elles s'intègrent harmonieusement dans tous les espaces repas en plein air. Un coussin moelleux vient parfaire l'ensemble, apportant une touche de confort supplémentaire pour des repas détendus en toute simplicité.





EN **Pulse** armchair with **Nomad** dining table
DE **Pulse** sofasessel mit **Nomad** Esstisch
FR **Pulse** fauteuils avec **Nomad** table de repas





EN **Pulse** armchairs with **Desert** dining table
DE **Pulse** sofasessel mit **Desert** Esstisch
FR **Pulse** fauteuils avec **Desert** table de repas







Aluminium Frame with wickerwork / Aluminiumrahmen mit Geflecht / structure aluminium et tressée



Colours/Farben/Couleurs: Sand/Anthracite



Removable cushions in 240 g Olefin. / Abnehmbare Kissen aus 240 g Olefin / Coussins déhoussables Olefin 240 g.



water-repellant / wasserabweisend / déperlant



Protective cover included / inklusive Schutzhülle / Housse de protection inclus

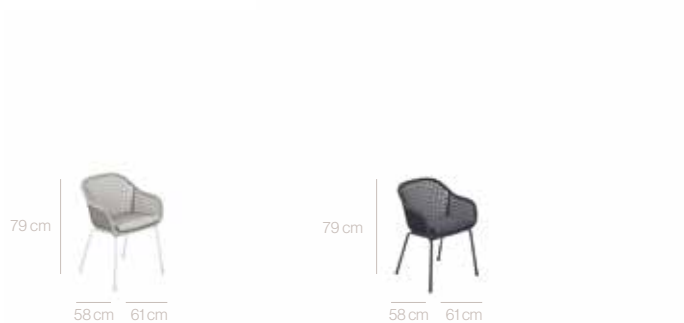

154597
Armchair / Stuhl / Fauteuil

Colour / Farbe / Couleur:

 Sand

 04

154595
Armchair / Stuhl / Fauteuil

Colour / Farbe / Couleur:

 Anthracite

 04

Pulse min. space / kleinste Fläche / espace minimum





KEMO

Mediterranean Ease, Redefined

EN KEMO captures the relaxed spirit of Mediterranean living with sleek aluminum frames, warm teak accents, and plush, inviting cushions. The palette combines soft off-white structures with deep olive green upholstery, evoking sun-drenched terraces and breezy coastlines. Elegant yet durable, this collection brings modern sophistication and cozy charm to your outdoor space.

Mediterrane Leichtigkeit, neu definiert

DE KEMO fängt den entspannten Geist des mediterranen Lebens ein – mit schlanken Aluminiumrahmen, warmen Teakholz-Akzenten und weichen, einladenden Kissen. Die Farbpalette vereint sanfte Off-White-Strukturen mit tiefolivgrüner Polsterung und erinnert an sonnenverwöhnte Terrassen und luftige Küstenlandschaften. Elegant und zugleich robust verleiht diese Kollektion Ihrem Außenbereich moderne Raffinesse und gemütlichen Charme.

La douceur méditerranéenne, réinventée

FR KEMO incarne l'esprit détendu de la vie méditerranéenne, avec ses structures en aluminium épurées, ses accoudoirs en teck et ses coussins moelleux et accueillants. Sa palette associe des structures blanc cassé à un revêtement vert olive profond, évoquant les terrasses baignées de soleil et les littoraux aérés. À la fois élégante et résistante, cette collection insuffle une touche de sophistication moderne et de douceur enveloppante à votre espace extérieur.







EN **KEMO** sofa set with: two armchairs; one two seater sofa, rectangular low lounge table
DE **KEMO** Sofa Set mit: zwei Sesseln, einem Zwei-Sitzer-Sofa, einem rechteckigen Lounge Tisch
FR **KEMO** Salon composé de deux fauteuils, un canapé 3 places et une table basse rectangulaire



EN **KEMO** dining stacking chairs with **KEMO** extension dining table with FSC®-certified Teak table top

DE **KEMO** Stapelbare Stühle mit **KEMO** Ausziehtisch mit Tischplatte aus FSC®-zertifiziertem Teakholz

FR **KEMO** fauteuils de repas empilables avec table de repas extensible **KEMO** avec plateau en teck certifié FSC®







Aluminium Frame / Aluminiumrahmen / Structure en aluminium



Removable cushions in sunbrella® / Abnehmbare Kissen aus sunbrella® / Coussins déhoussables sunbrella®



Colour / Farbe / Couleur: Sand



FSC®-certified Teak Armrests / FSC®-zertifizierte Armlehnen aus Teakholz / Accoudoirs en teck certifié FSC®



water-repellant / wasserabweisend / déperlant



Protective cover included / inklusive Schutzhülle / Housse de protection inclus



154588

Sofa Set / Sofa Set / Ensemble de canapés

01 Set / Package/Paket/ Paquet



Two Seater Sofa /
Zwei Sitzler Sofa /
Canapé 2 places

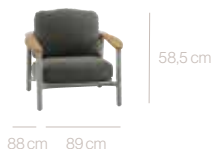

Armchair /
Sessel / Fauteuil



Coffee Table /
Lounge Tisch / Table basse



154528
Stacking Chair / Stapelstuhl /
Fauteuil empilable

18



154513
Extension Dining Table /
Ausziehbarer Esstisch /
Table de repas extensible

01

KEMO min. space / kleinste Fläche / espace minimum

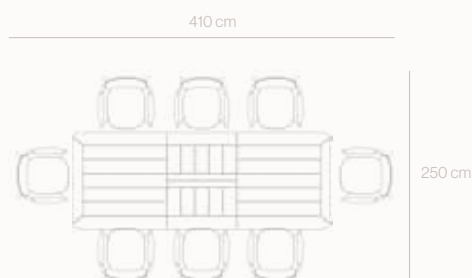



FOCOSA

Timeless lines with Effortless Functions

EN FOCOSA is a timeless range built for lasting performance with zero upkeep. Featuring lightweight aluminum frames and durable tabletops made from heat-cured natural minerals, it offers a sealed, weather-resistant surface. Blending minimalist design with smart functionality—like reclining chairs for personalized comfort — FOCOSA brings effortless durability and style to any outdoor space.

Zeitlose Linien mit müheloser Funktionalität

DE FOCOSA ist eine zeitlose Möbelsérie, die für dauerhafte Leistung ohne Wartungsaufwand entwickelt wurde. Mit leichten Aluminiumrahmen und langlebigen Tischplatten aus hitzegehärteten Naturmineralien bietet sie eine versiegelte, wetterfeste Oberfläche. Die Kombination aus minimalistischem Design und durchdachter Funktionalität – wie verstellbaren Stühlen für individuellen Komfort – verleiht jedem Außenbereich mühelose Langlebigkeit und Stil.

Lignes intemporelles et fonctionnalité sans effort

FR FOCOSA est une collection intemporelle conçue pour durer sans aucun entretien. Dotée de structures légères en aluminium et de plateaux robustes en minéraux naturels durcis à la chaleur, elle offre une surface résistante aux intempéries. Alliant design minimaliste et fonctionnalités astucieuses – comme des chaises inclinables pour un confort personnalisé – FOCOSA apporte durabilité et style sans effort à tout espace extérieur.





EN **Focosa** multiposition armchair, with Anthracite **Desert** side table

DE **Focosa** Multipositions Sessel, mit Beistelltisch **Desert**

FR **Focosa** fauteuil multipositions, avec table d'appoint **Desert**

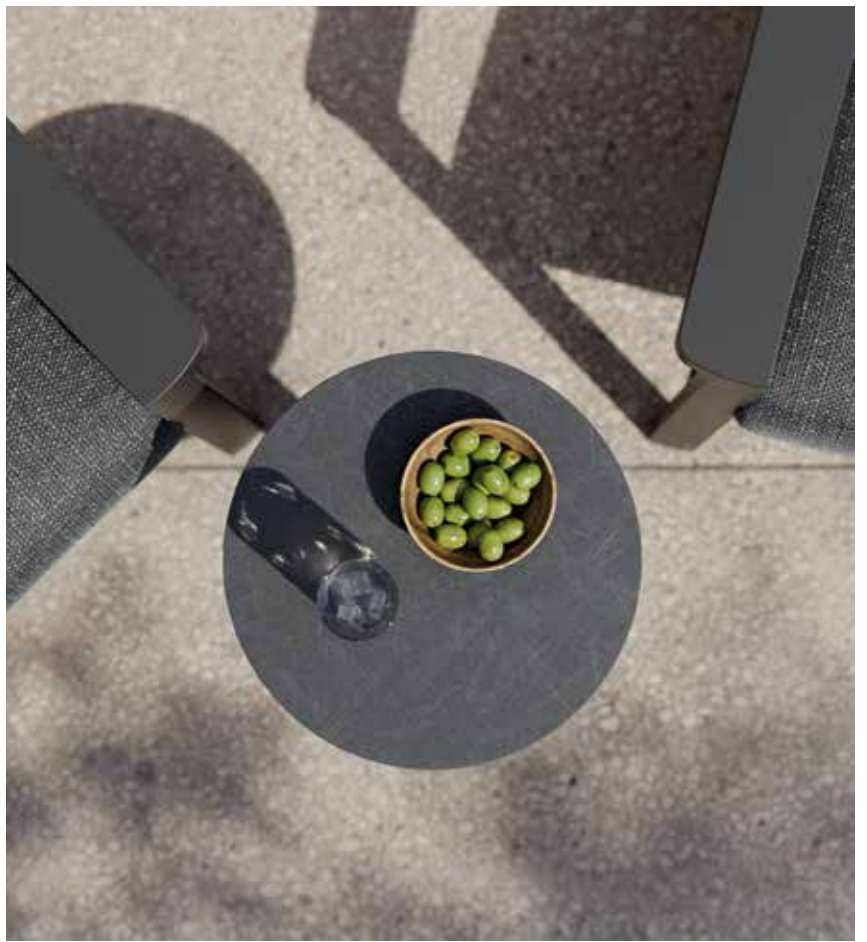



EN **Focosa** coffee set with: armchair, two seater sofa, rectangular low lounge table

DE **Focosa** Coffee-Set mit: Multipositions-Sessel; 2-Sitzer-Sofa, rechteckiger Lounge Tisch

FR **Focosa** Coffee set composé de deux fauteuils multipositions, d'un canapé 2 places et d'une table basse rectangulaire





EN **Focosa** Stacking armchairs
DE **Focosa** Stapelstuhl
FR **Focosa** Fauteuils empilables



EN **Focosa** Stacking armchairs with **Nomad** dining table
DE **Focosa** Stapelstuhl mit **Nomad** Esstisch
FR **Focosa** Fauteuils empilables avec **Nomad** table de repas





EN **Focosa** Adjustable armchair with **Nomad** dining table
DE **Focosa** verstellbarer Sessel mit **Nomad** Esstisch
FR **Focosa** fauteuils réglables avec **Nomad** table de repas





Aluminium Frame / Aluminiumrahmen / structure aluminium



Removable cushions in spun polyester 190 g. /
Abnehmbare Kissen aus 440 gr. Spunpolyester /
Coussins déhoussables spunpolyester 190 gr.



water-repellant / wasserabweisend / déperlant



Protective cover included / inklusive Schutzhülle /
Housse de protection inclus



Colour / Farbe / Couleur: Anthracite



6 mm Fairstone Tabletop / Plateau / Tischplatte



154158
Adjustable armchair /
Verstellbarer Komfort Sessel /
Fauteuil confortable réglable

02



154184
Stacking Chair /
Stapel Stuhl /
Fauteuil empilable

20



154168
Adjustable sofa /
Verstellbares sofa /
Canapé confortable
réglable

02



154176
Adjustable Chair /
Verstellbarer Stuhl /
Fauteuil réglable

2



154172
Armchair / Sessel / Fauteuil

02



154197
Height adjustable Table /
Höhenverstellbarer Tisch /
Table réglable en hauteur

02

Focosa min. space / kleinste Fläche / espace minimum

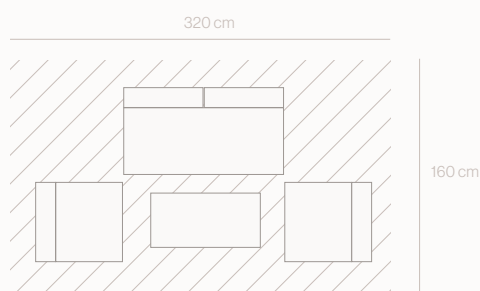



SKOVBRYN

Elegant style

EN Experience refined outdoor living with our sofa ensemble, carefully crafted from high-quality materials to ensure both stability and carefree ease of maintenance. Generously sized, weather-resistant cushions offer sumptuous comfort, while the elegantly designed chaise longue invites you to relax.

Eleganter Stil

DE Erleben Sie anspruchsvolles Outdoor-Living mit unserem Sofa-Ensemble, das sorgfältig aus hochwertigen Materialien gefertigt ist, um sowohl Stabilität als auch sorglose Pflegeleichtigkeit zu gewährleisten. Großzügig dimensionierte, wetterbeständige Polster bieten üppigen Komfort, während die elegant gestaltete Chaiselongue zur Entspannung einlädt.

Un style élégant

FR Faites l'expérience d'un art de vivre sophistiqué en plein air grâce à notre salon de jardin, soigneusement conçu à partir de matériaux haut de gamme pour allier stabilité, durabilité et facilité d'entretien. Les coussins généreux, résistants aux intempéries, offrent un confort luxueux, tandis que la chaise longue au design épuré invite naturellement à la détente.







EN **Skovbryn** corner sofa with round lounge table
DE **Skovbryn** Ecksofa mit rundem lounge Tisch
FR **Skovbryn** canapé d'angle avec table ronde basse



SKOVBRYN



Aluminium Frame / Aluminiumrahmen /
structure aluminium



Removable cushions in sunbrella® / Abnehmbare Kissen
aus sunbrella® / Coussins déhoussables sunbrella®.

 sunbrella®



water-repellant / wasserabweisend / déperlant



Protective cover included / inklusive Schutzhülle /
Housse de protection inclus



Colour / Farbe / Couleur: Anthracite



6 mm Fairstone Tabletop / Plateau / Tischplatte

154584

Sofa Set / Sofa Set / Ensemble de canapés



01 Set / 03 Packages/Pakete/ Cartons



Two Seater Sofa /
Zwei Sitzer Sofa /
Canapé 2 places



Two Seater Sofa /
Zwei Sitzer Sofa /
Canapé 2 places



Side Table /
Lounge Tisch / Table basse

Skovbryn min. space / kleinste Fläche / espace minimum

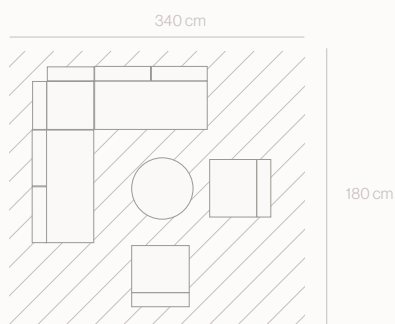



ELEGANCE

The natural elegance of romantic craftsmanship.

EN Elegance is a sophisticated combination of modern-sleek design and eye-catching elements of historical craftsmanship. The rounded shapes of the backrests make armchairs and bench superbly comfortable and create a worthy setting for the headrest's decorative ivy tendril, made of wrought-iron. Although being beautifully slim looking, provides Elegance the sturdiness and durability that Royal Garden is known for.

Die natürliche Eleganz handwerklicher Romantik.

DE Elegance schafft die perfekte Verbindung zwischen Design und funktionellem Komfort. Die Möbel sind aus Streckmetall gefertigt und haben eine wetterfeste Thermosint-Beschichtung. Die Applikation einer romantisch verspielten Efeu-Ranke am Kopfende verleiht Individualität und die besonders angenehme Sitzposition sorgt für die nötige Bequemlichkeit. Die Sessel haben eine schalenförmig gerundete Rückenlehne, lassen sich leicht übereinander stapeln und sind so platzsparend verstaubar.

L'élégance naturelle du romantisme artisanal.

FR Elegance incarne l'alliance parfaite entre design raffiné et confort fonctionnel. Fabriqué en métal étiré et doté d'un revêtement Thermosint résistant aux intempéries, ce mobilier conjugue charme et durabilité. Le détail ornemental en forme de liane de lierre, appliqué avec finesse sur la tête de lit, apporte une touche romantique et singulière. La position assise, particulièrement agréable, garantit un confort optimal. Les fauteuils, avec leur dossier arrondi en forme de coque, s'empilent facilement pour un rangement compact et sans effort.





EN **Elegance** Seat cushion with magnetic hold
DE **Elegance** Polster mit magnetischem Halt
FR **Elegance** Coussin d'assise avec maintien magnétique



ELEGANCE





EN **Elegance** Dining set with: stacking armchairs, **Royal Verso** Table, Seat cushion with magnetic hold

DE **Elegance** Dining Set mit: Stapelstuhl, **Royal Verso** Tisch, Polster mit magnetischem Halt

FR **Elegance** Ensemble de salle à manger avec : fauteuils empilables, table **Royal Verso**, Coussin d'assise avec maintien magnétique



EN **Elegance** Dining set with: stacking armchair, **Royal Verso** Table
DE **Elegance** Dining Set mit: Stapelstuhl, **Royal Verso** Tisch

FR **Elegance** Ensemble de salle à manger avec fauteuils empilables, table **Royal Verso**

ELEGANCE



Expanded Metal / Streckmetall / Métal étiré



water-repellant / wasserabweisend / déperlant



Colour / Farbe / Couleur: Anthracite

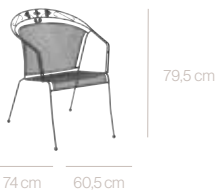

154017
Armchair /
Stuhl / Fauteuil

04



154018
Two Seater Bench /
Zwei Sitzer Bank / Banc 2 places

04

154547
Sofa Set / Sofa Set / Ensemble de canapés

01 Set / 2 Packages/Pakete/ Paquets



Protective cover included / inklusive Schutzhülle /
Housse de protection inclus

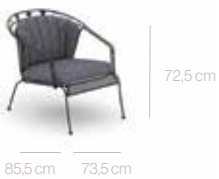

Armchair /
Sessel / Fauteuil

04



Two Seater Sofa /
Zwei Sitzer Sofa / Canapé 2 places

04



Koffee Table /
Lounge Tisch / Tables basses

01

Elegance min. space / kleinste Fläche / espace minimum

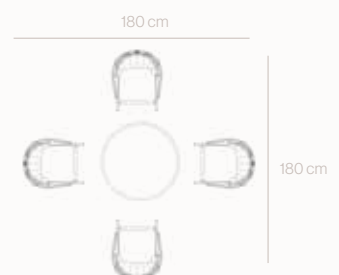
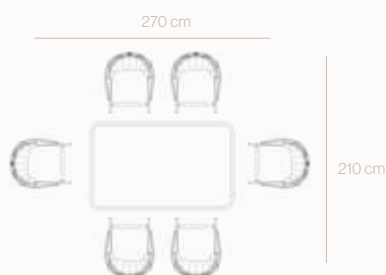
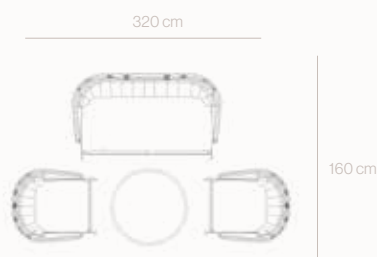



EXCELSIOR

Excellent interplay of elegance and comfort

EN Excelsior is stylishly in tune with the spirit of the times and yet has a nostalgic aura. The seat combination is made of solid iron, which has been crafted into expressive and gallant shapes, which are given a romantic finish by the free-standing spheres at the head of the backrests. The result is a range that skilfully combines historical flair and contemporary design aspects to create superior seating culture with luxurious comfort.

Exzellentes Zusammenspiel von Eleganz und Komfort

DE Excelsior trifft stilsicher den Zeitgeist und besitzt dennoch eine nostalgische Ausstrahlung. Die Sitzkombination besteht aus massivem Eisen, das kunsthandwerklich zu ausdrucksstarken und galanten Formen verarbeitet wurde, die durch die freistehenden Kugeln am Kopf der Rückenlehnen einen romantischen Abschluss erhielten. Dadurch entstand eine Reihe, die gekonnt historisches Flair und aktuelle Designaspekte zu souveräner Sitzkultur mit luxuriöser Bequemlichkeit verbindet.

Excellente combinaison d'élégance et de confort

FR Excelsior s'inscrit pleinement dans l'air du temps tout en cultivant un charme nostalgique. Fabriqué en fer massif, chaque siège est façonné de manière artisanale avec des lignes expressives et galantes. Les boules décoratives, disposées en haut des dossiers, apportent une touche romantique à l'ensemble. Cette collection marie avec finesse le raffinement historique et l'esthétique contemporaine, pour une expérience d'assise noble et un confort résolument luxueux.







- EN **Excelsior** Low back stacking armchairs
DE **Excelsior** Stapelbarer Stuhl mit niedriger Rückenlehne
FR **Excelsior** Fauteuils empilables à dossier bas





Expanded Metal / Streckmetall / Métal étiré



water-repellant / wasserabweisend / déperlant



Colour / Farbe / Couleur: Anthracite



154023
Low Back armchair /
Niedriglehner / Fauteuil
à dossier bas

04



154024
High Back armchair /
Hochlehner / Fauteuil
à dossier haut

04



154025
Two Seater Bench /
Zwei Sitzer Bank / Banc 2
places

04



154079
Wheellounger /
Rollenliege / Chaise
longue à roulettes

01

Excelsior min. space / kleinste Fläche / espace minimum

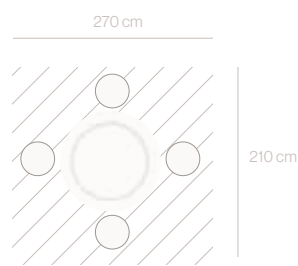
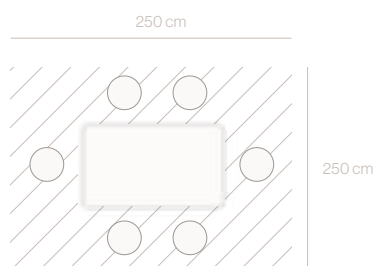



CAFFEO

Welcome to the sunny side of life

EN With this delicate set, great emotions are guaranteed - particularly on small spots. The sleek design and the heart-shaped contours in the back of the chairs create at any time of the day the perfect ambience for enjoying life on balcony or terrace with a touch of romance. Caffeo is also available with a creatop-basic tabletop.

Willkommen auf der Sonnenseite des Lebens

DE Diese filigrane Serie erzeugt gerade auf kleinen Flächen große Emotionen. Ihr graziles Design und die, in den Rückenlehnen der Stühle ausgearbeitete, Herzkontur schaffen zu jeder Tageszeit das perfekte Ambiente, um den Tag auf dem Balkon oder im Garten mit einem Hauch verspielter Romantik zu genießen. Caffeo ist auch mit creatop-basic Tischplatte erhältlich.

Bienvenue dans le côté ensoleillé de la vie

FR Avec cet ensemble raffiné, les émotions fortes sont garanties, en particulier dans les petits espaces. Le design élégant et les contours en forme de cœur à l'arrière des chaises créent à tout moment de la journée l'ambiance parfaite pour profiter de la vie sur le balcon ou la terrasse avec une touche de romantisme. Caffeo est également disponible avec un plateau creatop-basic.





EN **Caffeo** Coffee set: two chairs, one table
DE **Caffeo** Kaffee Set: zwei Stühle, ein Tisch
FR **Caffeo** Coffee set: deux chaises, une table



CAMILLE



CAFFEO



Expanded Metal / Streckmetall / Métal étiré



water-repellant / wasserabweisend / déperlant



Colour / Farbe / Couleur: Anthracite



154011
Chair /
Fleisch / Chaise

02



154648
Bistro table /
Bistro Tisch / Table de bistro

01

Caffeo min. space / kleinste Fläche / espace minimum

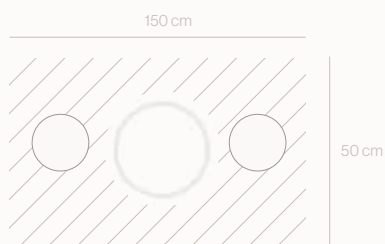



RICHMOND

Stylish elegance that delivers what it promises.

EN Attractive solidity and ergonomics with stylish elegance: its modern design language shows at first glance that Royal Richmond brings an exceptionally high level of seating comfort to the garden or patio. But in practical terms too, the set fully lives up to the promise of the Royal Garden name. Both the foldable and the stackable models impress with their reliable, weather-resistant robustness and can be stowed away to save space.

Stilvolle Eleganz, die hält, was sie verspricht.

DE Sehenswerte Solidität und Ergonomie mit stilvoller Eleganz: Seine moderne Formensprache zeigt bereits auf den ersten Blick, dass mit Royal Richmond ein außergewöhnlich hohes Maß an Sitzkomfort Einzug in den Garten oder auf die Terrasse hält. Doch auch in praktischer Hinsicht hält das Set voll und ganz, was der Name Royal Garden verspricht. Sowohl das klappbare als auch das stapelbare Modell überzeugen durch zuverlässig-wetterbeständige Robustheit und sind platzsparend verstaubar.

Une élégance stylée qui tient ses promesses.

FR Une solidité et une ergonomie remarquables alliées à une élégance stylée : son design moderne montre dès le premier coup d'œil qu'avec Royal Richmond, un niveau de confort d'assise exceptionnel fait son entrée dans le jardin ou sur la terrasse. Mais d'un point de vue pratique également, l'ensemble tient entièrement les promesses du nom Royal Garden. Tant le modèle pliable que le modèle empilable séduisent par leur robustesse fiable et résistante aux intempéries et peuvent être rangés de manière peu encombrante.







EN **Royal Richmond** Stacking Chair, Multiposition Chair, Sun Lounger, **Nomad** dining table
DE **Royal Richmond** Stapelstuhl, Multipositionsstuhl, Liegestuhl, **Nomad** Esstisch
FR **Royal Richmond** Fauteuil empilable, fauteuil multipositions, Chaise longue, **Nomad** table de repas



ROYAL RICHMOND



Aluminium Frame / Aluminiumrahmen /
structure aluminium



Textilene with Dry Foam padding / Textilene mit Dry Foam
Polsterung / Textilene avec rembourrage Dry Foam



Colour / Farbe / Couleur: Anthracite



water-repellant / wasserabweisend / déperlant



154151
Stacking Chair /
Stapelstuhl / Fauteuil empilable

14/16



154153
Multi Position Chair /
Multipositions Stuhl / Fauteuil
multipositions

02



154096
Wheellounger /
Rollenliege / Chaise longue
à roulettes

01

Royal Richmond min. space / kleinste Fläche / espace minimum

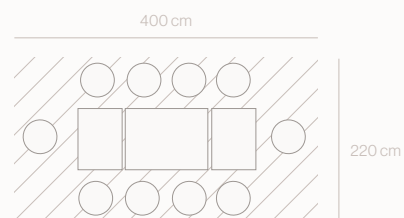
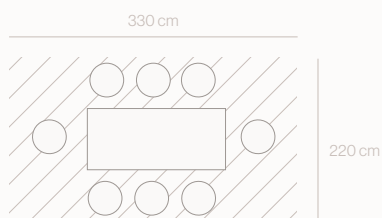
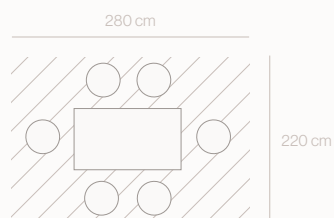



ROYAL KENSINGTON [PLUS]

Elegance and comfort, royally united

EN Royal Kensington embodies a stylish connection of timeless elegance and uncomplicated ease. Drawn from life, comfort is guaranteed amongst other features by the aluminium chairs' resilient coverings made of Textilene, which ensure at any time an ergonomic seating position. In addition to the excellent level of convenience, the chairs are marked by a pleasant flexibility, making them a perfect match to other "royal" relations: Royal Kensington PLUS offers additional seating comfort thanks to its textile upholstery optimised with dry foam padding and is the ideal addition to the Royal Kensington series. The chairs can be folded or stacked to save space and, thanks to their universal design, can be perfectly combined with each other.

Eleganz und Komfort, königlich vereint

DE Royal Kensington verkörpert die sehenswerte Vereinigung von zeitlos moderner Eleganz und unkomplizierter Leichtigkeit. Für Komfort sorgt dabei unter anderem die strapazierfähige, eine stets entspannende ergonomische Sitzhaltung gewährende Textilene-Bespannung der aus Aluminium gefertigten Stühle. Diese erweisen sich zudem als angenehm flexibel und ausgesprochen offen (nicht nur) für königliche Verbindungen: ROYAL KENSINGTON PLUS bietet durch seine, um eine Trockenschäum-Polsterung optimierte Textilenebespannung, zusätzlichen Sitzkomfort und ergänzt ideal die Royal Kensington Serie. Die Stühle sind platzsparend klapp- bzw. stapelbar und lassen sich dank ihres universell gehaltenen Designs optimal miteinander kombinieren.

Élégance et confort, royalement unis

FR Royal Kensington incarne une union entre élégance intemporelle et simplicité. Inspiré de la vie quotidienne, le confort est garanti, entre autres, par les revêtements résistants en Textilene des fauteuils en aluminium, qui assurent une position assise ergonomique. Outre leur excellent niveau de confort, les assises se caractérisent par une agréable flexibilité, ce qui les rend parfaitement compatibles avec les autres modèles « royaux » : Royal Kensington PLUS offre un confort d'assise supplémentaire grâce à son revêtement textile optimisé avec un rembourrage en mousse sèche et constitue le complément idéal de la série Royal Kensington. Les fauteuils peuvent être pliés ou empilés pour gagner de la place et, grâce à leur design universel, peuvent être parfaitement combinés entre elles.







EN **Royal Kensington** Stacking Chair, Multiposition Chair **Nomad** Extendable dining table
DE **Royal Kensington** Stapelstuhl, Multipositionsstuhl **Nomad** ausziehbarer Esstisch
FR **Royal Kensington** Fauteuil, fauteuil multipositions **Nomad** table de repas extensible



EN **Royal Kensington Plus Teak** Stacking Chair, Multiposition Chair
DE **Royal Kensington Plus Teak** Stapelstuhl, Multipositionsstuhl
FR **Royal Kensington Plus Teak** Fauteuil empilable, fauteuil multiposition



EN **Royal Kensington** Sun Lounger, Stool, **Desert** side table
DE **Royal Kensington** Liegestuhl, Hocker, **Desert** Beistelltisch
FR **Royal Kensington** Chaise longue, table d'appoint **Desert**

ROYAL KENSINGTON



Aluminium Frame / Aluminiumrahmen /
structure aluminium



Textilene / Textilene / Textilene



Colour / Farbe / Couleur: Iron Grey



water-repellant / wasserabweisend / déperlant



108,5 cm

75 cm 66,5 cm

154150
Royal Kensington Stacking Chair /
Stapelstuhl / Fauteuil empilable

14/16



110 cm

69 cm 67 cm

154152
Royal Kensington Multi Position
Chair / Multipositions Stuhl /
Fauteuil multipositions

02



110,5 cm

137,5 cm 71,5 cm

154195
Royal Kensington Lounger /
Liege / Chaise longue

01

ROYAL KENSINGTON [PLUS]



43 cm

49 cm 49 cm

154692
Royal Kensington Plus Folding
Stool / Klapphocker /
Tabouret pliable

01



111 cm

68,5 cm 63 cm

154693
Royal Kensington Plus Stacking
Chair / Stapelstuhl / Fauteuil
empilable

16/19



110 cm

69 cm 63 cm

154694
Royal Kensington Plus Multi
Position Chair /
Multipositions Stuhl / Fauteuil
multipositions

02



100,5 cm

174 cm 74,5 cm

154695
Royal Kensington Plus Wheelounger /
Rollenliege / Chaise longue à roulettes

01

ROYAL KENSINGTON PLUS TEAK



Aluminium Frame / Aluminiumrahmen / structure aluminium



Textilene / Textilene / Textilene



Colour / Farbe / Couleur: Anthracite



water-repellant / wasserabweisend / déperlant



FSC®-certified Teak Armrests / FSC®-zertifizierte Armlehnen aus Teakholz / Accoudoirs en teck certifié FSC®



111 cm

68,5 cm 63 cm

154706
Stacking Chair /
Stapelstuhl / Fauteuil empilable

16/19



110 cm

69 cm 63 cm

154707
Multi Position Chair /
Multipositions Stuhl / Fauteuil
multipositions

02



100,5 cm

174 cm 74,5 cm

154708
Wheellounger /
Rollenliege / Chaise longue à roulettes

01

Royal Kensington [Plus] min. space / kleinste Fläche / espace minimum

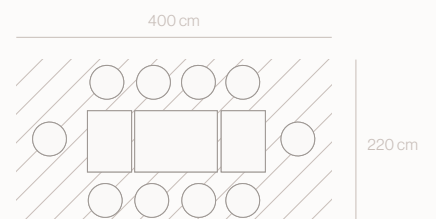
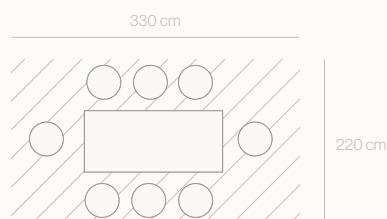
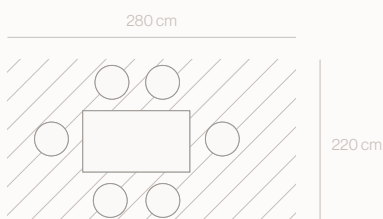



ROYAL OPERA

Elegance and comfort, royally united

EN The Royal Opera series includes stackable Aluminium armchairs with FSC®-certified Teak armrests and weather-resistant upholstered sunbrella® Textilene covers. With its fine and modern mix of materials, Royal Opera creates a homely ambience and invites you to spend leisure time in the garden.

Eleganz und Komfort, königlich vereint

DE Royal Opera kennzeichnet sich durch stapelbare Aluminium-Sessel mit FSC®-zertifizierten Teakholzarmlehnen und witterungsbeständigem gepolstertem sunbrella® Textilene-Bezug. Durch den feinen und modernen Materialmix erzeugt Royal Opera ein wohnliches Ambiente und lädt zum verweilen unter freiem Himmel ein.

Élégance et confort, royalement unis

FR Royal Opera se caractérise par des fauteuils empilables en aluminium avec des accoudoirs en teck certifiés FSC® et un revêtement en textilène sunbrella® rembourré et résistant aux intempéries. Grâce au mélange subtil et moderne des matériaux, Royal Opera crée une ambiance chaleureuse et invite à se détendre en plein air.







EN **Royal Opera** Stacking chair, **Nomad** dining table
DE **Royal Opera** Stapelstuhl, **Nomad** Esstisch
FR **Royal Opera** Fauteuil empilable, **Nomad** table de repas





Aluminium Frame / Aluminiumrahmen / Structure en aluminium



Colour / Farbe / Couleur: Matt Grey



sunbrella® Textilene with Dry Foam padding /
sunbrella® Textilene mit Dry Foam Polsterung /
sunbrella® Textilene avec rembourrage Dry Foam



water-repellant / wasserabweisend / déperlant



FSC®-certified Teak Armrests / FSC®-zertifizierte Armlehnen aus
Teakholz / Accoudoirs en teck certifié FSC®



154481
Stacking Chair /
Stapelstuhl / Fauteuil empilable

19/22

Opera min. space / kleinste Fläche / espace minimum

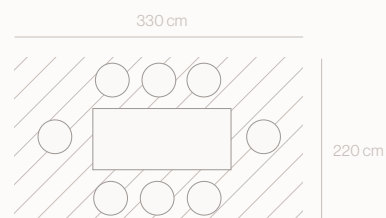
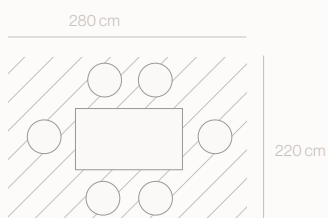



ROYAL DAYBED DELUXE

Luxurious leisure time

EN The Royal Daybed Deluxe brings pure luxury to the garden or terrace. It offers comfortable reclining with multiple adjustable headrests and footrests. Whether for reading on a shady island, relaxing or taking a break with cool drinks in the partial shade: adjustable roof slats and fold-out shelves make the Royal Daybed Deluxe an all-round talent that leaves nothing to be desired.

Luxuriöse Freizeit

DE Mit dem Royal Daybed Deluxe erhält purer Luxus Einzug in den Garten oder auf die Terrasse. Denn es bietet komfortables Liegen durch mehrfach verstellbare Kopf- sowie Fußlehnen. Ob zum Lesen auf einer schattigen Ruheinsel, zum Entspannen oder für eine Auszeit mit kühlen Getränken im Halbschatten: verstellbare Dachlamellen und herausklappbare Ablageflächen machen das Royal Daybed Deluxe zu einem Allround- Talent, das keine Wünsche offenlässt.

Loisirs de luxe

FR Le Royal Daybed Deluxe apporte une touche de luxe à votre jardin ou terrasse. Il offre un confort optimal grâce à ses multiples appuis-tête et repose-pieds réglables. Que ce soit pour lire à l'ombre, se détendre ou faire une pause avec une boisson fraîche à l'ombre partielle, les lattes réglables du toit et les tablettes rabattables font du Royal Daybed Deluxe un meuble polyvalent qui comble tous les désirs.





ROYAL DAYBED DELUXE



EN **Daybed** with adjustable head- and foodrest and fold-out shelves
DE **Daybed** mit verstellbaren Kopf- und Fußlehnen sowie ausklappbaren Ablageflächen
FR **Daybed** avec appuie-tête et repose-pieds réglables ainsi que des plateaux de rangement dépliables



ROYAL DAYBED DELUXE



Aluminium Frame / Aluminiumrahmen /
structure aluminium



water-repellant / wasserabweisend / déperlant



Colour / Farbe / Couleur: Anthracite



154792

Daybed with adjustable head- and footrest and fold-out shelves /
Daybed mit verstellbaren Kopf- und Fußlehnen sowie
ausklappbaren Ablageflächen /
Daybed avec appuie-tête et repose-pieds réglables ainsi que des
plateaux de rangement dépliables



Royal Daybed Deluxe min. space / kleinste Fläche / espace minimum

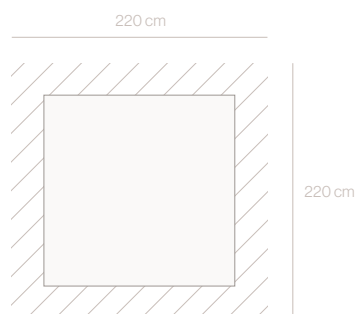



TABLES

Built to Endure, Season after season

EN Royal garden creates some of the most sturdy and hard wearing tables in the industry. Built for lasting performance with zero upkeep. Our tables feature lightweight aluminum frames and durable tabletops made from heat-cured natural minerals, offering a sealed, weather-resistant surface. Effortless durability and style to any outdoor space.

Gebaut für Beständigkeit – Saison für Saison

DE Royal Garden fertigt einige der robustesten und strapazierfähigsten Tische der Branche. Entwickelt für dauerhafte Leistung ohne Wartungsaufwand. Unsere Tische verfügen über leichte Aluminiumrahmen und langlebige Tischplatten aus hitzegehärteten Naturmineralien, die eine versiegelte, wetterfeste Oberfläche bieten. Mühelose Langlebigkeit und Stil für jeden Außenbereich.

Conçu pour durer, saison après saison

FR Royal Garden crée parmi les tables les plus solides et résistantes de l'industrie. Conçues pour offrir des performances durables sans aucun entretien. Nos tables sont dotées de structures en aluminium léger et de plateaux durables en minéraux naturels durcis à la chaleur, offrant une surface solide et résistante aux intempéries. Une durabilité et un style sans effort pour tous les espaces extérieurs.







EN **Nomad** extendable dining table with Fairstone® Tabletop
DE **Nomad** ausziehbarer Esstisch mit Fairstone® Tischplatte
FR **Nomad** Table de repas extensible avec plateau en Fairstone®

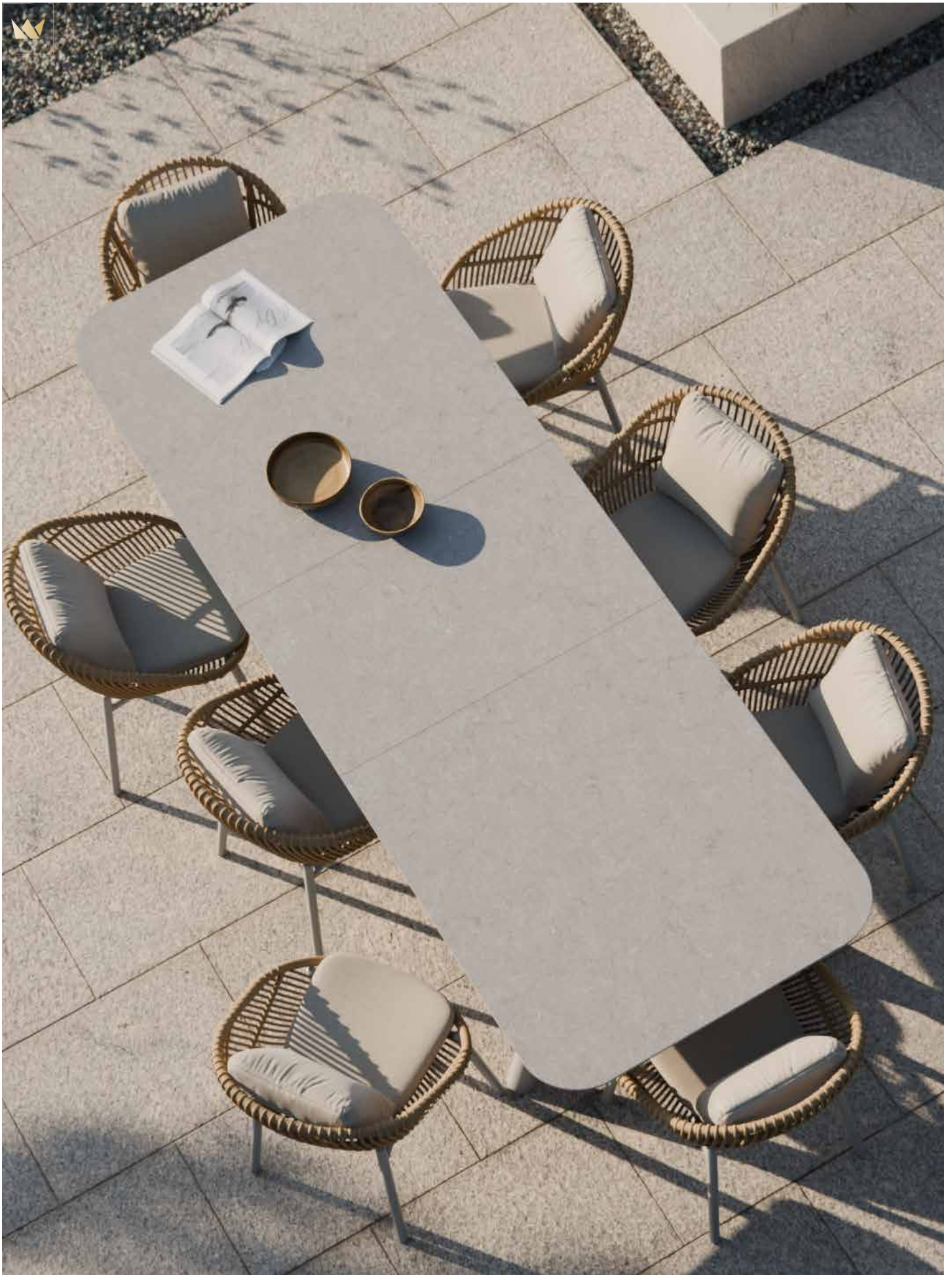



EN **Free** dining table with Fairstone® Tabletop
DE **Free** Esstisch mit Fairstone® Tischplatte
FR **Free** Table de repas extensible avec plateau en Fairstone®





EN **Desert**, Oval dining table with Fairstone® Table top
DE **Desert**, Ovaler Esstisch mit Fairstone® Tischplatte
FR **Desert**, Table de repas ovale avec plateau en Fairstone®



EN **Desert**, round side tables with Fairstone® Table top, dia 90 cm/dia 60 cm
DE **Desert**, runde Beistelltische mit Fairstone® Tischplatte, ø 90 cm/ø 60 cm
FR **Desert**, Tables basses rondes avec plateau en Fairstone®, ø 90 cm/ø 60 cm



EN **Desert**, round side table with Fairstone® Table top, dia 60 cm
DE **Desert**, runder Beistelltisch mit Fairstone® Tischplatte, ø 60 cm
FR **Desert**, Table basse ronde avec plateau en Fairstone®, ø 60 cm





TABLES



Aluminium Frame / Aluminiumgestell / structure aluminium



water-repellant / wasserabweisend / déperlant



Colour / Farbe / Couleur: Anthracite / Sand



6 mm Fairstone Tabletop / Tischplatte / Plateau

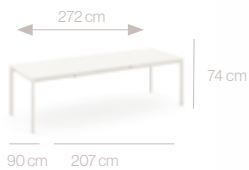

**154599
Nomad**
Rectangular Extension Table /
Rechteckiger Auszugstisch / Table
d'extension rectangulaire

Colour / Farbe / Couleur:

Sand

01



**154604
Nomad**
Rectangular Dining Table /
Rechteckiger Esstisch / Table de
repas rectangulaire

Colour / Farbe / Couleur:

Sand

01



**154619
Nomad**
Square Lounge Table /
Quadratischer Lounge Tisch /
Table de salon carré

Colour / Farbe / Couleur:

Sand

01



**154598
Nomad**
Rectangular Extension Table /
Rechteckiger Auszugstisch / Table
d'extension rectangulaire

Colour / Farbe / Couleur:

Anthracite

01



**154603
Nomad**
Rectangular Dining Table /
Rechteckiger Esstisch / Table de
repas rectangulaire

Colour / Farbe / Couleur:

Anthracite

01



**154621
Nomad**
Lounge Table / Lounge Tisch /
Table de salon

Colour / Farbe / Couleur:

Sand

01



**154601
Nomad**
Rectangular Dining Table /
Rechteckiger Esstisch / Table de
repas rectangulaire

Colour / Farbe / Couleur:

Sand

01



**154600
Nomad**
Rectangular Dining Table /
Rechteckiger Esstisch / Table de
repas rectangulaire

Colour / Farbe / Couleur:

Anthracite

01



Aluminium Frame / Aluminiumrahmen /
structure aluminium



6 mm Fairstone Tabletop / Tischplatte / Plateau



water-repellant / wasserabweisend / déperlant



Colour / Farbe / Couleur: Anthracite / Sand



154643

Free

Rectangular Dining Table /
Rechteckiger Esstisch / Table
de repas rectangulaire

Colour / Farbe / Couleur:

 Sand

 01



154646

Free

Rectangular Extension Table /
Rechteckiger Auszugstisch /
Table d'extension rectangulaire

Colour / Farbe / Couleur:

 Sand

 01

TABLES



Frame / Gestell / Structure: Aluminium/Steel



Colour / Farbe / Couleur: Anthracite / Sand



6 mm Fairstone Tabletop / Tischplatte / Plateau



water-repellant / wasserabweisend / déperlant

DINING



154251
Desert
Round / Rund / Ronde

Colour / Farbe / Couleur:

Sand

01



154436
Desert
Round / Rund / Ronde

Colour / Farbe / Couleur:

Anthracite

01



154637
Desert
Round / Rund / Ronde

Colour / Farbe / Couleur:

Sand

01

LOUNGE



154248
Desert
Round / Rund / Ronde

Colour / Farbe / Couleur:

Sand

01



154250
Desert
Round / Rund / Ronde

Colour / Farbe / Couleur:

Anthracite

01



154439
Desert
Round / Rund / Ronde

Colour / Farbe / Couleur:

Sand

01



154443
Desert
Round / Rund / Ronde

Colour / Farbe / Couleur:

Anthracite

01



Frame / Gestell / Structure: Aluminium/Steel



water-repellant / wasserabweisend / déperlant



Colour / Farbe / Couleur: Anthracite / Sand



6 mm Fairstone Tabletop / Tischplatte / Plateau



154242
Urban
Folding Table / Klapp Tisch /
Table pliante

Colour / Farbe / Couleur:

Sand

01



154244
Urban
Folding Table / Klapp Tisch /
Table pliante

Colour / Farbe / Couleur:

Anthracite

01



Frame / Gestell / Structure: Steel



water-repellant / wasserabweisend / déperlant



Colour / Farbe / Couleur: Anthracite / Sand



Steel Tabletop / Stahl Tischplatte / Acier Plateau



154647
Pi
Round Coffee Table Set /
Rundes Lounge Tisch Set /
Table basse rond

01

TABLES



Aluminium Frame / Aluminiumrahmen /
structure aluminium



Expanded Metal / Streckmetall / Métal déployé



Colour / Farbe / Couleur: Anthracite



water-repellant / wasserabweisend / déperlant



154654
Royal Verso
Round / Rund / Rond

01



154198
Royal Verso
Round / Rund / Rond

10



154668
Universal
Rectangular / Rechteckig /
Rectangulaire

01



154541
Universal
Rectangular / Rechteckig /
Rectangulaire

01



Aluminium Frame / Aluminiumrahmen /
structure aluminium



Colour / Farbe / Couleur: Anthracite



12 mm Fairstone Tabletop / Tischplatte / Plateau



water-repellant / wasserabweisend / déperlant



154762
Alutapo
Square Dining Table /
Quadratischer Esstisch / Table de
repas carrée

Colour / Farbe / Couleur:

Anthracite

01



Aluminium Frame / Aluminiumrahmen / structure aluminium



Colour / Farbe / Couleur: Anthracite / Sand



6 mm Fairstone Tabletop / Tischplatte / Plateau



water-repellant / wasserabweisend / déperlant



154121
Norden
Square Coffee Table /
Quadratischer Lounge Tisch /
Table basse Carré



154118
Norden
Rectangular Coffee Table /
Rechteckiger Lounge Tisch /
Table basse Rectangulaire



154122
Norden
Round Coffee Table / Round
Lounge Tisch / Table basse Ronde



VALEA



Aluminium Frame / Aluminiumrahmen / structure aluminium



Removable cushions in sunbrella® / Abnehmbare Kissen aus sunbrella®
/ Coussins déhoussables sunbrella®



Colour / Farbe / Couleur: Anthracite



6 mm Fairstone Tabletop / Tischplatte / Plateau



water-repellant / wasserabweisend / déperlant



Protective cover included / inklusive Schutzhülle /
Housse de protection inclus



154796

Sofa Set

 01



VALEA



BELLEZZA



Aluminium Frame / Aluminiumrahmen /
structure aluminium



water-repellant / wasserabweisend / déperlant



Colour / Farbe / Couleur: White / Light grey



154794

Sofa Set

 01

BASSO



Aluminium Frame / Aluminiumrahmen / structure aluminium



Colour / Farbe / Couleur: Anthracite



FSC®-certified Teak Tabletop / Tischplatte / Plateau



water-repellant / wasserabweisend / déperlant



Protective cover included / inklusive Schutzhülle /
Housse de protection inclus



154791
Sofa Set

 01



BASSO

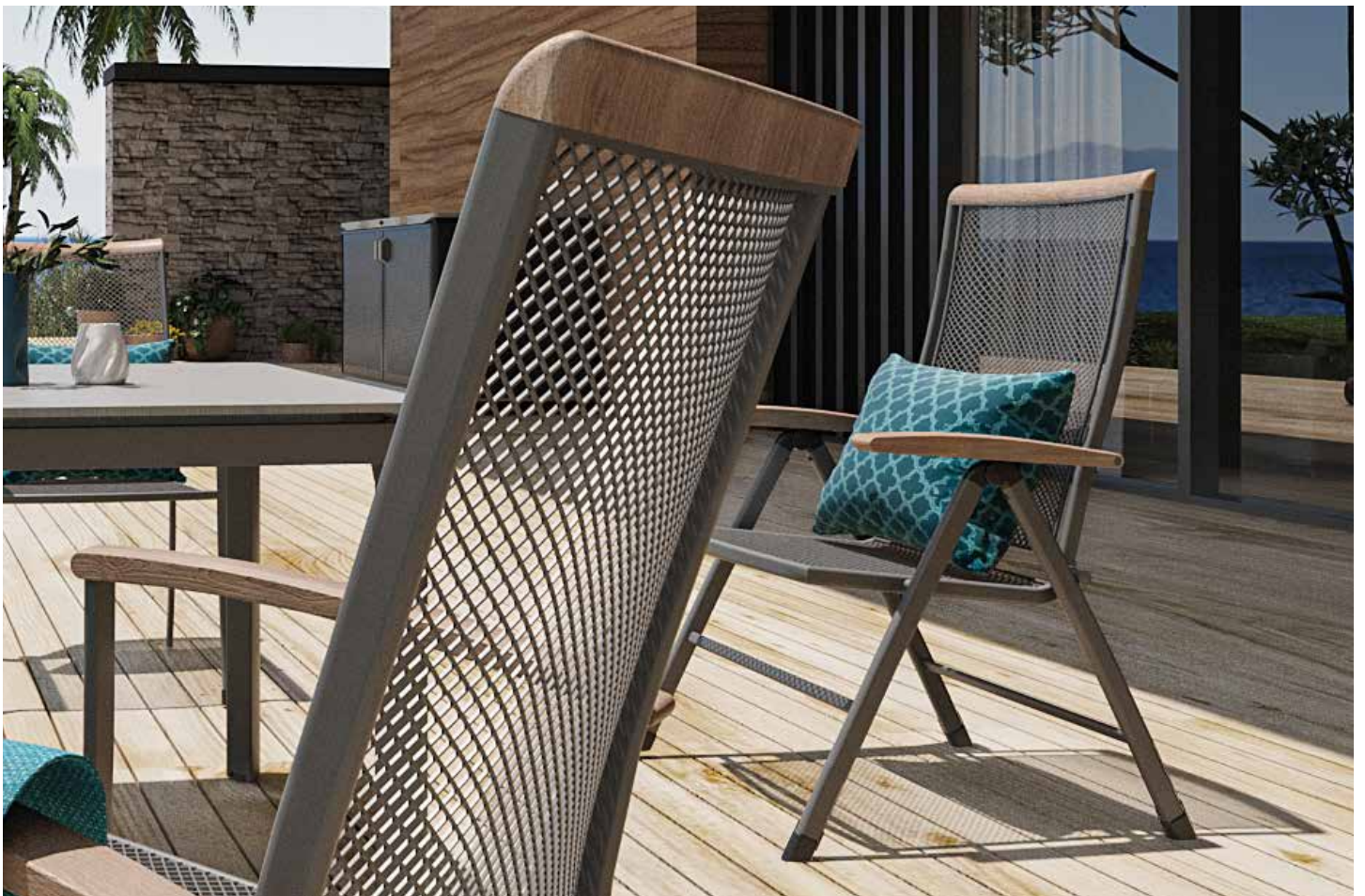

BALERO



Expanded Metal / Streckmetall / Métal étiré



Colour / Farbe / Couleur: Anthracite



FSC®-certified Teak Armrests / FSC®-zertifizierte Armlehnen aus Teakholz / Accoudoirs en teck certifié FSC®



water-repellant / wasserabweisend / déperlant



154759
Armchair /
Stuhl / Fauteuil

04

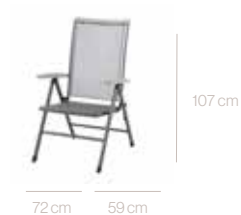

154760
Multi Position Chair /
Multipositions Stuhl / Fauteuil
multipositions

01



154761
Wheellounger /
Rollenliege / Chaise longue à roulettes

01

ROYAL RIVIERA



Steel Frame / Stahlrahmen /
structure acier



water-repellant / wasserabweisend / déperlant



Wicker / Kunststoffgeflecht / résine tressée



Colour / Farbe / Couleur: Anthracite



154763
Armchair /
Stuhl / Fauteuil

 04



ROYAL RIVIERA



ROYAL CHESTER



Aluminium Frame / Aluminiumrahmen /
structure aluminium



water-repellant / wasserabweisend / déperlant



Colour / Farbe / Couleur: Anthracite



60 cm

58 cm 132 cm

154776
Cushion box /
Kissenbox / Coffre de rangement

 01



80 cm

78,5 cm 160,5 cm

154777
Cushion box /
Kissenbox / Coffre de rangement

 01



122 cm

110 cm 206 cm

154778
Cushion box /
Kissenbox / Coffre de rangement

 01



PARASOLS

Shade: Refined

EN Discover our collection of premium parasols and umbrellas, designed to combine lasting performance with timeless aesthetics. Crafted for both residential and contract settings, every piece in the range is built from superior, weather-resistant materials that require no maintenance. Available in palette that goes from deep anthracite to soft sand tones, including elegant wood-effect finishes. With fully replaceable components, our parasols offer long lasting elegance and practicality, season after season.

Schatten, Neu Definiert

DE Entdecken Sie unsere Kollektion hochwertiger Sonnenschirme, die dauerhafte Leistung mit zeitloser Ästhetik vereinen. Für den privaten wie auch den gewerblichen Einsatz konzipiert, wird jedes Modell aus erstklassigen, wetterbeständigen Materialien gefertigt – ganz ohne Wartung. Die Farbpalette reicht von tiefem Anthrazit bis zu sanften Sandtönen, ergänzt durch stilvolle Holzoptik-Oberflächen. Dank vollständig austauschbarer Komponenten bieten unsere Sonnenschirme dauerhafte Eleganz und praktische Funktionalität – Saison für Saison.

Ombre, Réinventée

FR Découvrez notre collection de parasols haut de gamme, conçue pour allier performance durable et esthétique intemporelle. Adaptés aussi bien aux espaces résidentiels qu'aux projets contract, chaque modèle est fabriqué à partir de matériaux supérieurs, résistants aux intempéries et sans entretien. Disponibles dans une palette allant de l'anthracite profond aux tons sable doux, avec également des finitions élégantes effet bois. Dotés de composants entièrement remplaçables, nos parasols allient élégance durable et fonctionnalité, saison après saison.







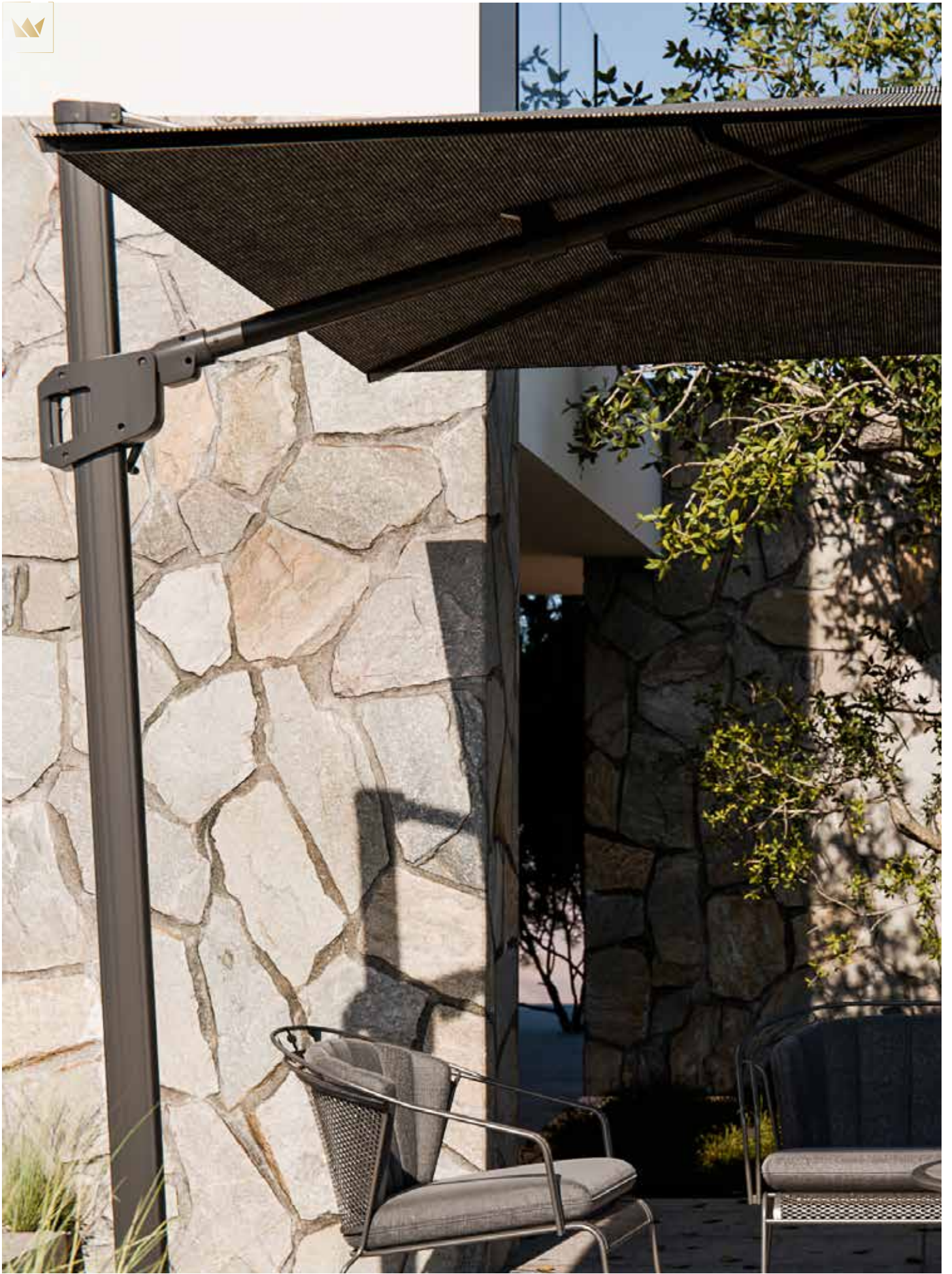

ROYAL NIDO



Aluminium Frame / Aluminiumrahmen / structure aluminium



water-repellant / wasserabweisend / déperlant



Protective cover included / inklusive Schutzhülle /
Housse de protection inclus



Frame Colour / Gestellfarbe / Couleur armature:
Wood Look / Sand / Anthracite



solar LED light / solar LED Beleuchtung / Éclairage solaire LED



154667
Parasol / Sonnenschirm / Ombrelle

 Colour / Farbe / Couleur: Wood Look

 01

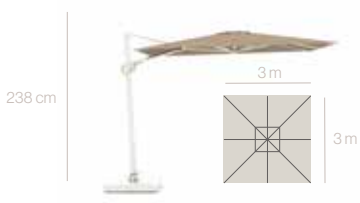

154672
Parasol / Sonnenschirm / Ombrelle

 Colour / Farbe / Couleur: Sand

 01



154673
Parasol / Sonnenschirm / Ombrelle

 Colour / Farbe / Couleur: Anthracite

 01

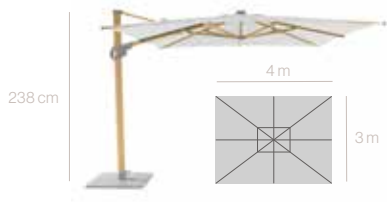

154676
Parasol / Sonnenschirm / Ombrelle

 Colour / Farbe / Couleur: Wood Look

 01

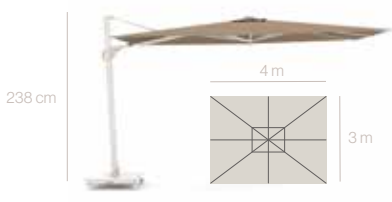

154679
Parasol / Sonnenschirm

 Colour / Farbe / Couleur: Sand

 01



154682
Parasol / Sonnenschirm / Ombrelle

 Colour / Farbe / Couleur: Anthracite

 01



154683
Base with wheels and brake /
Schirmständer mit Rollen und Bremse /
Base avec avec des roues et frein

 Colour / Farbe / Couleur: Marble

 130 kg

 01







ROYAL CORO



Aluminium Frame / Aluminiumrahmen / structure aluminium



water-repellant / wasserabweisend / déperlant



Protective cover included / inklusive Schutzhülle /
Housse de protection inclus



Frame Colour / Gestellfarbe / Couleur armature:
Wood Look / Sand / Anthracite



solar LED light / solar LED Beleuchtung / Éclairage solaire LED



154735

Parasol / Sonnenschirm / Ombrelle

 Colour / Farbe / Couleur: Wood Look

 01



154736

Parasol / Sonnenschirm / Ombrelle

 Colour / Farbe / Couleur: Sand

 01



154737

Parasol / Sonnenschirm / Ombrelle

 Colour / Farbe / Couleur: Anthracite

 01



154738

Marble base with 2 wheels /
Marmor Schirmständer mit zwei Rollen
/ Base de marbre avec deux roues

 Colour / Farbe / Couleur: Marble

 35 kg

 01









Aluminium Frame / Aluminiumrahmen / structure aluminium



water-repellant / wasserabweisend / déperlant



Protective cover included / inklusive Schutzhülle /
Housse de protection inclus



Frame Colour / Gestellfarbe / Couleur armature:
Wood Look / Sand / Anthracite

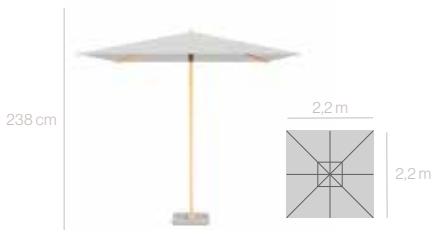

154684

Parasol / Sonnenschirm / Ombrelle

 Colour / Farbe / Couleur: Wood Look

 01



154689

Parasol / Sonnenschirm / Ombrelle

 Colour / Farbe / Couleur: Sand

 01



154701

Parasol / Sonnenschirm / Ombrelle

 Colour / Farbe / Couleur: Anthracite

 01



154710

Steel base with 2 wheels /
Stahl-Schirmständer zwei Rollen / Base
de Acier avec deux roues

 Colour / Farbe / Couleur: Sand

 25 kg

 01



154731

Steel base with 2 wheels /
Stahl-Schirmständer zwei Rollen / Base
de Acier avec deux roues





 Colour / Farbe / Couleur: Anthracite

 25 kg







 01



DIRECTORY / VERZEICHNIS / ANNUAIRE

-  Aluminium
-  Expanded Metal / Streckmetall / Métal étiré
-  water-repellant / wasserabweisend / déperlant
-  Protective cover available / Schutzhülle erhältlich / Housse de protection disponible
-  loading qty. / Lademenge / Unité de vente
-  LED lighting with magnetic holder / LED Beleuchtung mit Magnethalterung / LED avec support magnétique
-  solar LED lighting / solar LED Beleuchtung / Éclairage solaire LED
-  UV resistant / UV beständig / résistant aux UV
-  Plastic Mesh / Kunststoffgeflecht / résine tressée
-  Olefin: water-repellant / wasserabweisend / déperlant

Colours / Farben / Couleurs:

-  Sand
-  Light Grey
-  Anthracite
-  Chocolate
-  FSC®-certified Teak
-  Wood Look



for commercial use / für gewerbliche Nutzung / pour usage commercial



5 years guarantee* on the entire Royal Garden range /
5 Jahre Garantie* auf das gesamte Royal Garden Sortiment /
5 ans de garantie* sur tout l'assortiment Royal Garden

*against perforation corrosion / gegen Durchrostung / contre la perforation par la rouille





EN No guarantee for the immediate availability of all products. Delivery time can take up to eight weeks. No guarantee can be assumed for the completeness or correctness of all statements. The colours and décors that appear in the catalogue may differ from the original colours due to the technical printing process. DE Keine Garantie für die sofortige Verfügbarkeit aller Produkte. Lieferzeiten können bis zu acht Wochen dauern. Keine Garantie für Richtigkeit und Vollständigkeit aller Angaben. Abbildungen und Farben können produktionsbedingt abweichen. FR Aucune garantie de disponibilité immédiate de tous les produits. Les délais de livraison peuvent aller jusqu'à huit semaines. Aucune garantie quant à l'exactitude et l'exhaustivité de toutes les informations. Les illustrations et les couleurs peuvent varier en fonction de la production.

Edition 25/1

All rights reserved
© MWH GmbH



ROYAL GARDEN
EST. 1992

Royal Garden

MWH GmbH Member of Yotrio Group / Blindeisenweg 23 / 41468 Neuss